

# AICOK

COFFEE MAKER  
INSTRUCTION MANUAL

CM4682-V



## **IMPORTANT SAFEGUARDS**

Before using the electrical appliance, the following basic precautions should always be followed including the following:

1. Read all instructions.
2. Before using check that the voltage of wall outlet corresponds to rated voltage marked on the rating plate.
3. This appliance has been incorporated with a grounded plug. Please ensure the wall outlet in your house is well earthed.
4. To protect against fire, electric shock and injury to persons do not immerse cord, plug in water or other liquid.
5. Remove plug from wall outlet before cleaning and when not in use. Allow appliance cool down completely before taking off, attaching components or before cleaning.
6. Do not operate any appliance with a damaged cord or plug or after the appliance malfunctions, or is dropped or damaged in any manner, return appliance to the nearest authorized service facility for examination, repair or electrical or mechanical adjustment.
7. The use of accessory attachments not recommended by the appliance manufacturer may result in fire, electric shock or injury to persons.
8. Place appliance on flat surface or table, do not hang power cord over the edge of table or counter.
9. Ensure the power cord do not touch hot surface of appliance.
10. Do not place the coffee maker on hot surface or beside fire in order to avoid to be damaged.
11. To disconnect, remove plug from wall outlet. Always hold the plug. But never pull the cord.
12. Do not use appliance for other than intended use and place it in a dry environment.
13. Close supervision is necessary when your appliance is being used near children.

14. Be careful not to get burned by the steam.
15. Do not touch the hot surface of appliance (such as steam wand, and the steel mesh just boiling). Use handle or knobs.
16. Do not let the coffee maker operate without water.
17. Do not remove the metal funnel when appliance in brewing coffee or when steam.
18. Connect plug to wall outlet before using and turn any switch off before plug is removed from wall outlet.
19. This appliance is not intended for use by persons (including children) with reduced physical, sensory or mental capabilities, or lack of experience and knowledge, unless they have been given supervision or instruction concerning use of the appliances by a person responsible for their safety.
20. Children should be supervised to ensure that they do not play with the appliance.
21. The environment temperature of operating or storing shall be more than 0°C.
22. This appliance is intended to be used in household and similar applications such as:
  - staff kitchen areas in shops, offices and other working environments;
  - farm houses;
  - by clients in hotels, motels and other residential type environments;
  - bed and breakfast type environments.
23. Do not use outdoors.
24. Save these instructions.

# KNOW YOUR COFFEE MAKER

(Product may be subject to change without prior notice)

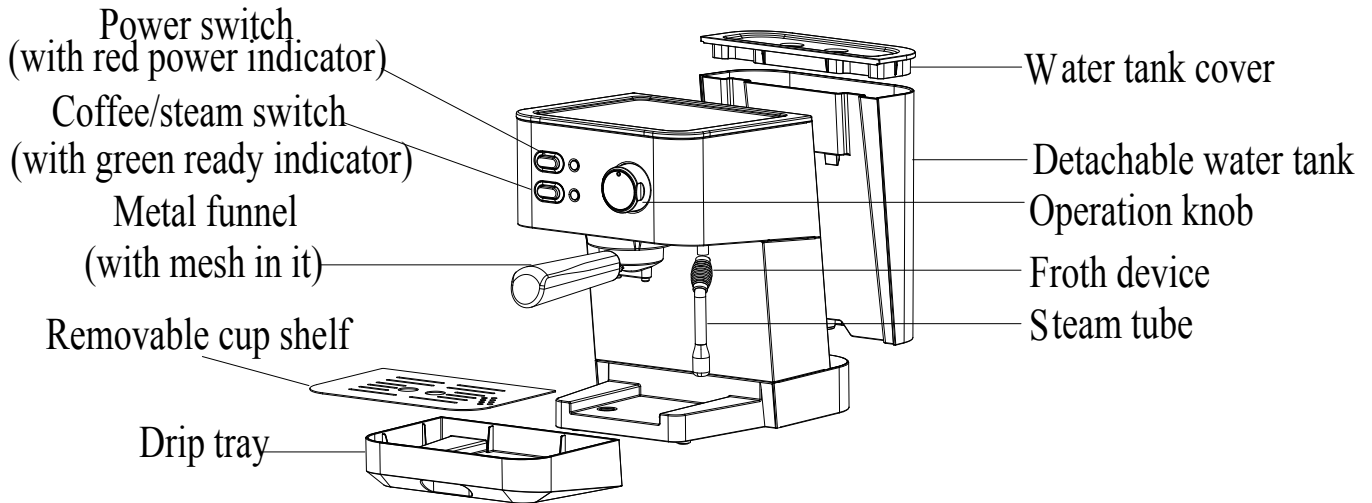

## BEFORE THE FIRST USE

To ensure the first cup of coffee tastes excellent, you should rinse the coffee maker with water as follows:

1. Pour water into water tank, the water level should not exceed the “MAX” mark in the tank. Then close the water tank cover.

**Note:** the appliance is supplied with a detachable tank for easy cleaning, you can fill the tank with water firstly, and then put the tank into the appliance.

2. Set steel mesh into metal funnel (no coffee in steel mesh), make sure the tube on the funnel aligns with groove in the appliance, then insert the funnel into the appliance from the “INSERT” position, and you can fix them into coffee maker firmly by turning it anticlockwise until it is at the “LOCK” position.

3. Place an espresso cup (your cup) on removable cup shelf. Make sure the operation knob is on the “O” position.

**Note:** the appliance is not equipped with jug, please use your jug or coffee cup.

4. Connect to power source, press the power switch to the lower position which is the “ON” position. The power indicator will be illuminated. The appliance will start heating

5. Press down the Coffee/steam button to the higher position which is the “☕” position, waiting for a moment, until the ready indicator lights, it shows the pre-heating is finished. Turn the operation knob to the



 position. The water will flow out.

6. After about one minute, turn the operation knob to the “O” position to stop brewing, you can pour the water in container out then clean them thoroughly, now you can start brewing.

**Note:** There may be noise when pumping the water on the first time, it is normal, the appliance is releasing the air in the appliance. After about 20s, the noise will disappear.

## PREHEATING

To make a cup of good hot Espresso coffee, we recommend you shall preheat the appliance before making coffee, including the funnel, steel mesh and cup, so that the coffee flavour can not be influenced by the cold parts.

1. Remove the detachable tank and open the tank cover to fill it with desired water, the water level should not exceed the “MAX” mark in the tank. Then place the tank into the appliance properly.
2. Set steel mesh into metal funnel (without coffee powder), make sure the tube on the funnel aligns with groove in the appliance, then insert the funnel into the appliance from the “INSERT” position, and you can fix them into coffee maker firmly by turning it anticlockwise until it is at the “LOCK” position.
3. Place an espresso cup (your cup) on removable cup shelf.
4. Then connect the appliance to power source. Make sure the operation knob is on the “O” position.
5. Press down the ON/OFF button to the lower position which is the “” position. The red indicator will be illuminated.
6. The appliance will start heating.
7. Press down the Coffee/steam button to the higher position which is the “” position, waiting for a moment, until the ready indicator lights, it shows the pre-heating is finished.

## MAKING ESPRESSO

1. Remove the metal funnel by turning it in clockwise, set steel mesh into metal funnel. Add coffee powder to steel mesh with measuring spoon, a spoon of coffee powder can make about a cup of top-grade coffee, then press the ground coffee powder tightly with the tamper.
2. Then insert the funnel into the appliance from the “INSERT” position and release the press bar, and you can fix them into coffee maker firmly by turning it anticlockwise until it is at the “LOCK” position.
3. Pour out the hot water in the cup. Then place the hot cup (your cup) on removable cup shelf.
4. At the time, the ready indicator is illuminated, turn the operation knob to the “” position. The coffee will flow out.

**Note:** During brewing coffee or making steam, it is normal that the green indicator is likely to extinguish, it only means that the heater is heating up to keep the temperature at the standard range.

5. You should turn the operation knob to the “O” position when desired coffee is obtained or the colour of coffee changes weak obviously, then press the power switch to the higher switch, the power indicator and ready indicator go out and the coffee maker stops working, your coffee is ready now.

**WARNING:** Do not leave the coffee maker unattended during making the coffee, as you need operate manually sometimes!

6. After finishing making the coffee, you can take the metal funnel out by turning it clockwise, then pour the coffee residue out with the steel mesh pressed by press bar.

7. Let them cool down completely, then rinse under running water.

## MAKING CAPPUCCINO

You get a cup of cappuccino when you top up a cup of espresso with frothing milk.

**Note:** during making steam, the metal funnel must be assembled in position.

### Method:

1、 Prepare espresso first with container big enough according to the part “MAKE ESPRESSO COFFEE”, make sure that the operation knob is at the “O”.

2、 Press the coffee/steam switch to lower position which is the  position, waiting for until the ready indicator is illuminated.

3、 Fill a jug with about 100 grams of milk for each cappuccino to be prepared, you are recommended to use whole milk at refrigerator temperature (not hot!).

**Note:** In choosing the size of jug, it is recommended the diameter is not less than  $70 \pm 5$ mm, and bear in mind that the milk increases in volume by 2 times, make sure the height of jug is enough.

4、 Insert the froth device into the milk about two centimetre, then turn the operation knob to the “” position, steam will come out from the steam outlet. Froth milk in the way moving vessel round from up to down.

5. When the required purpose is reached, you can turn the operation knob to the “O” position.

**Note:** Clean steam outlet with wet sponge immediately after steam stops generating, but care not to hurt!

6. Pour the frothed milk into the espresso prepared, now the cappuccino is ready. Sweeten to taste and if desired, sprinkle the froth with a little cocoa powder.

7. Press the power switch to the higher position to cut off the power source.

**Note:** after making steam, we recommended you allow the maker to cool down at least for 5 min before making coffee again. Otherwise burnt odor may occur in your Espresso coffee.

## PRODUCING STEAM TO HEAT LIQUIDS OR BEVERAGE

The steam wand can be used to make hot beverages like drinking chocolate, water or tea.

### Method:

1. Remove the detachable tank and fill it with desired water, the water level should not exceed the “MAX” mark in the tank. Then place the tank into the appliance properly.

2. Then connect the appliance to power source. Press the power switch to the lower position, the power indicator will illuminated.

3. Press the coffee/steam switch to higher position which is the  position, waiting for until the ready indicator is illuminated.

4. Dip the steam wand without froth device sleeve into the liquid to be heated or the intended froth milk.

Turn the operation knob to the “” position.

5. When the required temperature is reached, you can turn the operation knob to the “O” position.

7. Press the power switch to the “O” position to cut off the power source.

## CLEANING AND MAINTENANCE

- 1、 Cut off power source and let the coffee maker cool down completely before cleaning.
- 2、 Clean housing of coffee maker with moisture-proof sponge often and clean water tank, drip tray and removable shelf regularly then dry them.

**Note:** Do not clean with alcohol or solvent cleanser. Never immerse the housing in water for cleaning.

- 3、 Detach the metal funnel by turning it clockwise, get rid of coffee residue inside, then you can clean it with cleanser, but at last you must rinse with clear water.
- 4、 Clean all the attachments in the water and dry thoroughly.

## CLEANING MINERAL DEPOSITS

1. To make sure your coffee maker operating efficiently, internal piping is cleanly and the peak flavor of coffee, you should clean away the mineral deposits left every 2-3 months.



2. Fill the tank with water and descaler to the MAX level ( the scale of water and descaler is 4:1, the detail refers to the instruction of descaler. Please use “household descaler”, you can use the citric acid (obtainable from chemist’s or drug stores) instead of the descaler (the one hundred parts of water and three parts of citric acid).

3. According to the program of pre-heating, put the metal funnel (no coffee powder in it) and carafe (jug) in place. Brewing water per “ PRE-HEATING”.

4. Press the power switch to the lower position which is the “ON” position. The power indicator will be illuminated. The appliance will start heating.

5. Press down the Coffee/steam button to the higher position which is the “☕” position, waiting for a moment, until the ready indicator lights, it shows the pre-heating is finished.

6. Turn the operation knob to the “☕” position and make two cups coffee (about 2Oz). Then turn it to the “O” position.

7. Press the coffee/steam switch to lower position which is the  position, waiting for until the ready indicator is illuminated. Turn the operation knob to the “” position and make steam for 2min, then turn the operation knob to the “O” position to stop making steam. Press the power switch to the higher position to stop the unit immediately, make the descaler deposit in the unit at least 15 minutes.

8. Restart the unit and repeat the steps of 4-7 at least 3 times.

9. Then brewing coffee (no coffee powder) with tap water in the MAX level, repeat the steps of 4-7 for 3 times (it is not necessary to wait for 15 minutes in step of 7), then brewing until no water is left in the tank.

## TROUBLE SHOOTING

Symptom	Cause	Corrections
---------	-------	-------------



Water leaks from the bottom of coffee maker.	There is much water in the drip tray.	Please clean the drip tray.
	The coffee maker is malfunction.	Please contact with the authorized service facility for repairing.
Acid (vinegar) taste exists in Espresso coffee.	No clean correctly after cleaning mineral deposits.	Clean coffee maker per the content in “before the first use” for several times.
	The coffee powder is stored in a hot, wet place for a long time. The coffee powder turns bad.	Please use fresh coffee powder, or store unused coffee powder in a cool, dry place. After opening a package of coffee powder, reseal it tightly and store it in a refrigerator to maintain its freshness.
The coffee maker cannot work any more.	The power outlet is not plugged well.	Plug the power cord into a wall outlet correctly, if the appliance still does not work, please contact with the authorized service facility for repairing.
The steam cannot froth.	The ready indicator is not illuminated.	Only after the ready indicator is illuminated, the steam can be used to froth.
	The container is too big or the shape is not fit.	Use high and narrow cup.
	You have used skimmed milk	Use whole milk or half-skimmed milk

*Do not take apart the appliance by yourself if the cause of failure is not found, you had better contact certified serving center.*

## Environment friendly disposal

You can help protect the environment!  
Please remember to respect the local regulations: hand in the non-working electrical equipments to an appropriate waste disposal center.

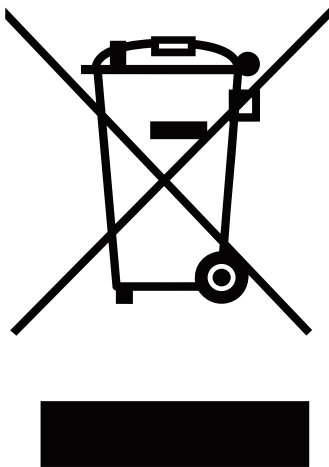







**Aicok Home Essentials Live Comfortable**

Shenzhen Impression E-commerce Co.,Ltd  
Booth No.3H012,Trading Plaza,No.5,Huanan city,  
Pinghu Street,Longgang District,Shenzhen,China  
Facebook Page: <https://www.facebook.com/aicoks/>

Website:[www.aicok.cc](http://www.aicok.cc)

**Made In China**